

Trend Line 750 FHTL 604 3G TC GF C Grafite |

106.0183.092

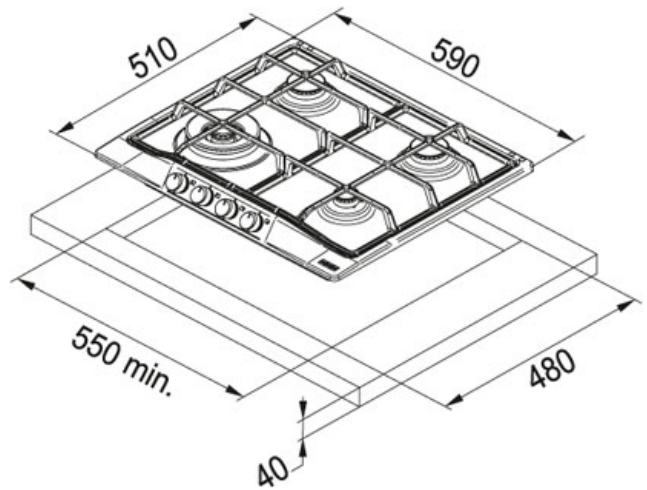





FAMIGLIA : Piani Cottura | SERIE : Trend Line 750 | MODELLO : FHTL 604 3G TC GF C | FINITURA : Grafite |
INSTALLAZIONE : Incasso



DATI TECNICI

Potenza (W)	Ausiliario 1000W Semirapido 1750W Tripla Corona 3800W
Tipo di controllo	Manopole
Griglie in dotazione	Ghisa
Lunghezza totale	590,00 mm
Larghezza totale	510,00 mm
Type	Gas
Numero Fuochi	4
Dimensioni	590x510
Foro Incasso	550x480

FUNZIONI

	Accensione elettronica integrata		Tripla corona
	Valvola di sicurezza		Griglie in ghisa in dotazione
			Kit manopole optional
	AISI 304		